



SAW multimedia filters

Series/Type: M1971M

The following products presented in this data sheet are being withdrawn.

Ordering Code	Substitute Product	Date of Withdrawal	Deadline Last Orders	Last Shipments
B39458M1971M100		2011-01-14	2011-09-30	2012-09-30

For further information please contact your nearest EPCOS sales office, which will also support you in selecting a suitable substitute. The addresses of our worldwide sales network are presented at www.epcos.com/sales.

© EPCOS AG 2015. Reproduction, publication and dissemination of this publication, enclosures hereto and the information contained therein without EPCOS' prior express consent is prohibited.

EPCOS AG is a TDK Group Company.

SAW Components
M 1971 M
IF Filter for Intercarrier Applications
45,75 MHz
Data Sheet
Standard

 Plastic package **SIP5K**

- M/N

Features

- TV IF filter with Nyquist slope and sound shelf
- Constant group delay

Terminals

- Tinned CuFe alloy

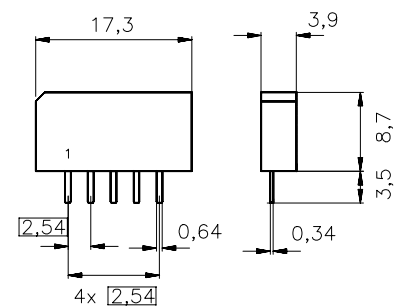
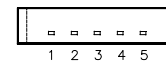

Dimensions in mm, approx. weight 1,0 g

Pin configuration

- | | |
|---|-----------------------|
| 1 | Input |
| 2 | Input - ground |
| 3 | Chip carrier - ground |
| 4 | Output |
| 5 | Output |

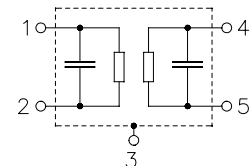

Type	Ordering code	Marking and package according to	Packing according to
M 1971 M	B39458-M1971-M100	C61157-A1-A15	F61074-V8067-Z000

Maximum ratings

Operable temperature range	T_A	-25/+65	°C	
Storage temperature range	T_{stg}	-40/+85	°C	
DC voltage	V_{DC}	5	V	between any terminals
AC voltage	V_{pp}	10	V	between any terminals

SAW Components
M 1971 M
IF Filter for Intercarrier Applications
45,75 MHz
Data Sheet
Characteristics

Reference temperature: $T_A = 25 (45) \text{ }^\circ\text{C}$
 Terminating source impedance: $Z_S = 50 \text{ } \Omega$
 Terminating load impedance: $Z_L = 2 \text{ k}\Omega \parallel 3 \text{ pF}$

		min.	typ.	max.	
Insertion attenuation					
	α				
Reference level for the following data	44,06 (44,00) MHz	10,8	12,3	13,8	dB
Relative attenuation					
	α_{rel}				
Picture carrier	45,81 (45,75) MHz	5,3	6,0	6,7	dB
Color carrier	42,23 (42,17) MHz	1,0	2,0	3,0	dB
Sound carrier	41,31 (41,25) MHz	15,6	17,1	18,6	dB
Adjacent picture carrier	39,81 (39,75) MHz	46,5	60,0	—	dB
Adjacent sound carrier	47,31 (47,25) MHz	46,5	55,0	—	dB
Lower sidelobe					
	35,06 ... 39,81 (35,00 ... 39,75) MHz	36,5	41,0	—	dB
Upper sidelobe					
	47,31 ... 55,06 (47,25 ... 55,00) MHz	38,5	44,0	—	dB
Reflected wave signal suppression					
1,1 μs ... 6,0 μs after main pulse (test pulse 250 ns, carrier frequency 44,06 MHz)		42,0	52,0	—	dB
Feedthrough signal suppression					
1,0 μs ... 0,9 μs before main pulse (test pulse 250 ns, carrier frequency 44,06 MHz)		50,0	56,0	—	dB
Group delay ripple (p-p)	$\Delta\tau$	—	40	—	ns
Impedance at 44,06 MHz					
Input: $Z_{\text{IN}} = R_{\text{IN}} \parallel C_{\text{IN}}$		—	1,5 \parallel 10,6	—	k Ω \parallel pF
Output: $Z_{\text{OUT}} = R_{\text{OUT}} \parallel C_{\text{OUT}}$		—	1,0 \parallel 3,6	—	k Ω \parallel pF
Temperature coefficient of frequency	TC_f	—	-72	—	ppm/K

Data Sheet

Frequency response

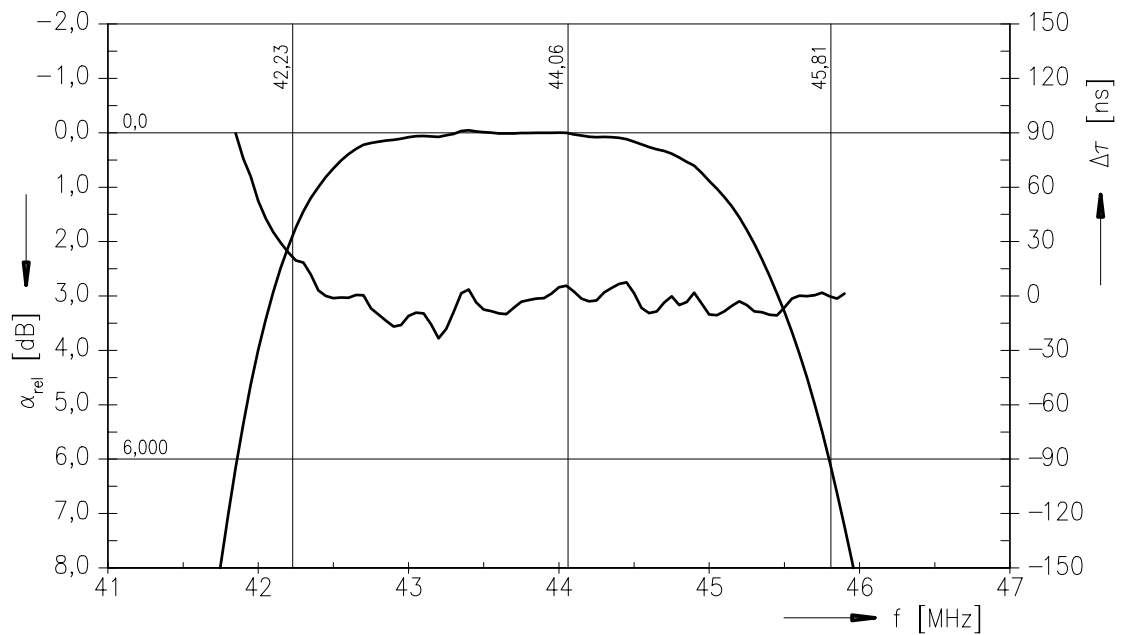
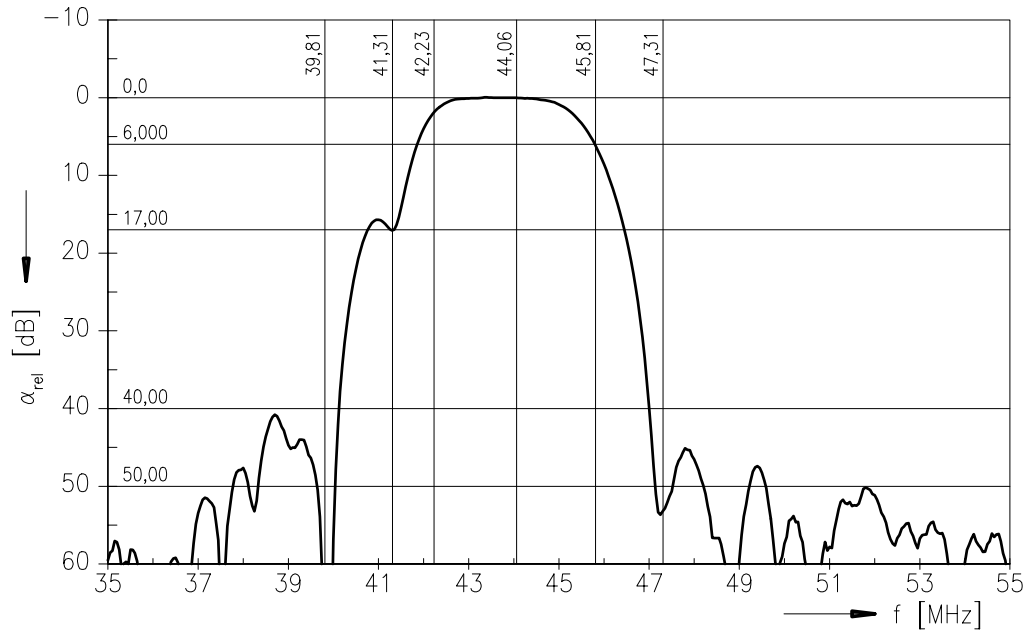

Data Sheet

Frequency response

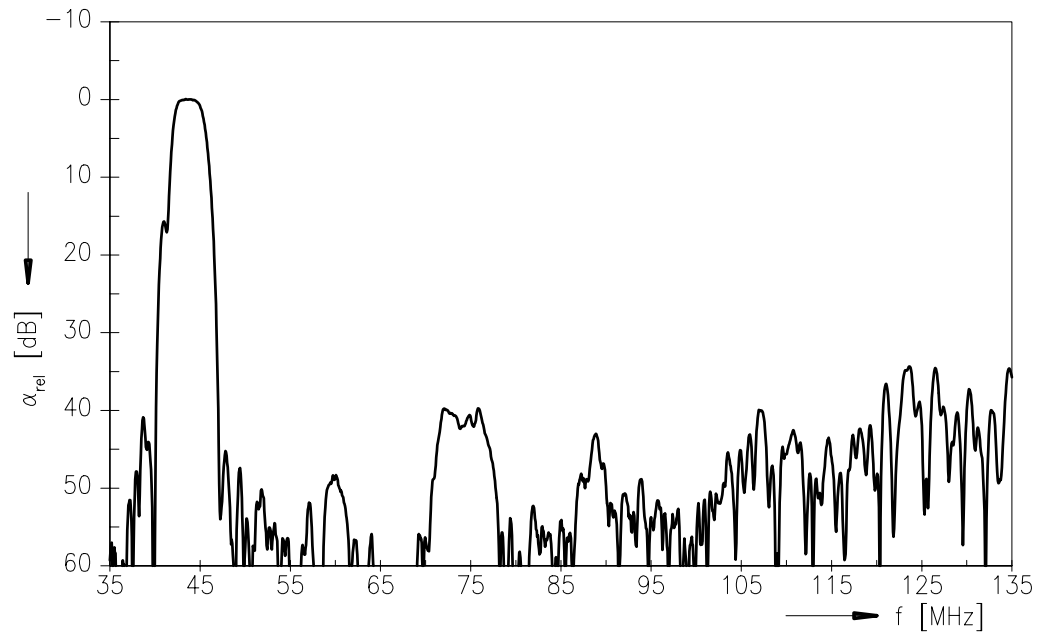

Time domain response

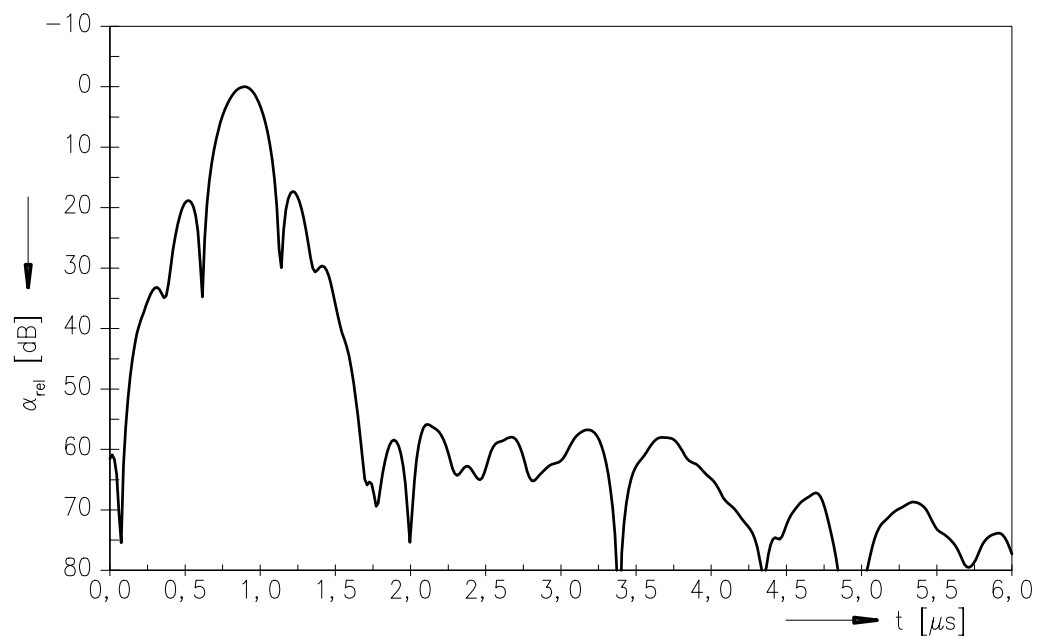

Published by EPCOS AG**Surface Acoustic Wave Components Division, SAW CE MM PD****P.O. Box 80 17 09, D-81617 München**

© EPCOS AG 2001. All Rights Reserved.

As far as patents or other rights of third parties are concerned, liability is only assumed for components per se, not for applications, processes and circuits implemented within components or assemblies.

The information describes the type of component and shall not be considered as assured characteristics.

Terms of delivery and rights to change design reserved.

For questions on technology, prices and delivery please contact the sales offices of EPCOS AG or the international representatives.

Due to technical requirements components may contain dangerous substances. For information on the type in question please also contact one of our sales offices.