

Heterojunction Bipolar Transistor Technology (InGaP HBT)

Broadband High Linearity Amplifier

The MMG3015N is a General Purpose Amplifier that is internally Input and output matched. It is designed for a broad range of Class A, small-signal, high linearity, general purpose applications. It is suitable for applications with frequencies from 0 to 6000 MHz such as Cellular, PCS, BWA, WLL, PHS, CATV, VHF, UHF, UMTS and general small-signal RF.

Features

- Frequency: 0-6000 MHz
- P1dB: 20.5 dBm @ 900 MHz
- Small Signal Gain: 15.5 dB @ 900 MHz
- Third Order Output Intercept Point: 36 dBm @ 900 MHz
- Single 5 Volt Supply
- Active Bias
- Internally Matched to 50 Ohms
- Low Cost SOT-89 Surface Mount Package
- RoHS Compliant
- In Tape and Reel. T1 Suffix = 1,000 Units per 12 mm, 7 inch Reel.

MMG3015NT1

**0-6000 MHz, 15.5 dB
20.5 dBm
InGaP HBT**

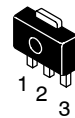

**CASE 1514-02, STYLE 1
SOT-89
PLASTIC**

Table 1. Typical Performance (1)

Characteristic	Symbol	900 MHz	2140 MHz	3500 MHz	Unit
Small-Signal Gain (S21)	G_p	15.5	14.5	12.5	dB
Input Return Loss (S11)	IRL	-15	-19	-19	dB
Output Return Loss (S22)	ORL	-13	-9	-7	dB
Power Output @1dB Compression	P1db	20.5	20.5	18.5	dBm
Third Order Output Intercept Point	IP3	36	33.5	30.5	dBm

1. $V_{CC} = 5$ Vdc, $T_C = 25^\circ\text{C}$, 50 ohm system

Table 2. Maximum Ratings

Rating	Symbol	Value	Unit
Supply Voltage (2)	V_{CC}	7	V
Supply Current (2)	I_{CC}	300	mA
RF Input Power	P_{in}	12	dBm
Storage Temperature Range	T_{stg}	-65 to +150	$^\circ\text{C}$
Junction Temperature (3)	T_J	150	$^\circ\text{C}$

2. Continuous voltage and current applied to device.

3. For reliable operation, the junction temperature should not exceed 150°C .

Table 3. Thermal Characteristics ($V_{CC} = 5$ Vdc, $I_{CC} = 95$ mA, $T_C = 25^\circ\text{C}$)

Characteristic	Symbol	Value (4)	Unit
Thermal Resistance, Junction to Case	$R_{\theta JC}$	41.5	$^\circ\text{C}/\text{W}$

4. Refer to AN1955, *Thermal Measurement Methodology of RF Power Amplifiers*. Go to <http://www.freescale.com/rf>. Select Documentation/Application Notes - AN1955.

Table 4. Electrical Characteristics ($V_{CC} = 5$ Vdc, 900 MHz, $T_C = 25^\circ\text{C}$, 50 ohm system, in Freescale Application Circuit)

Characteristic	Symbol	Min	Typ	Max	Unit
Small-Signal Gain (S21)	G_p	14	15.5	—	dB
Input Return Loss (S11)	IRL	—	-15	—	dB
Output Return Loss (S22)	ORL	—	-13	—	dB
Power Output @ 1dB Compression	P1dB	—	20.5	—	dBm
Third Order Output Intercept Point	IP3	—	36	—	dBm
Noise Figure	NF	—	5.6	—	dB
Supply Current (1)	I_{CC}	80	95	120	mA
Supply Voltage (1)	V_{CC}	—	5	—	V

1. For reliable operation, the junction temperature should not exceed 150°C .

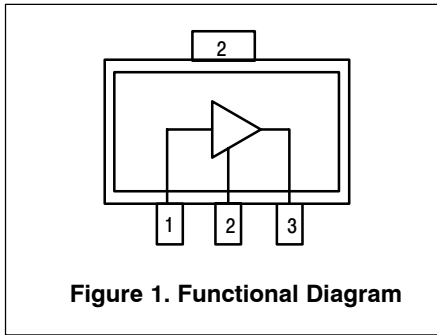

Table 5. Functional Pin Description

Pin Number	Pin Function
1	RF _{in}
2	Ground
3	RF _{out} /DC Supply

Table 6. ESD Protection Characteristics

Test Methodology	Class
Human Body Model (per JESD 22-A114)	1C (Minimum)
Machine Model (per EIA/JESD 22-A115)	A (Minimum)
Charge Device Model (per JESD 22-C101)	IV (Minimum)

Table 7. Moisture Sensitivity Level

Test Methodology	Rating	Package Peak Temperature	Unit
Per JESD 22-A113, IPC/JEDEC J-STD-020	1	260	°C

50 OHM TYPICAL CHARACTERISTICS

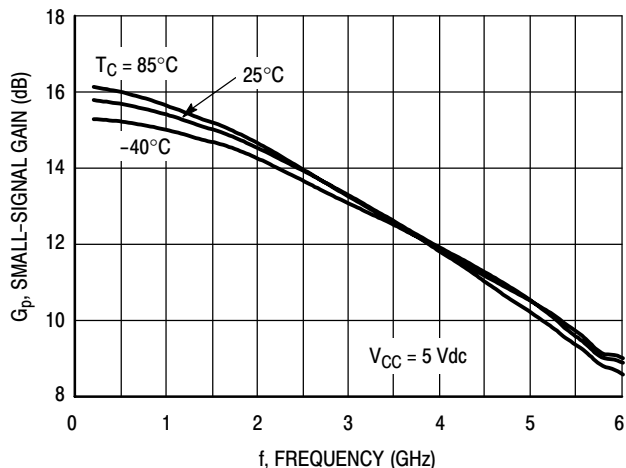

Figure 2. Small-Signal Gain (S21) versus Frequency

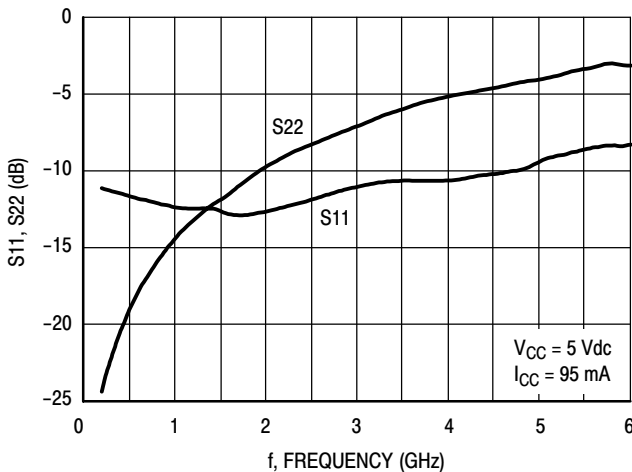

Figure 3. Input/Output Loss versus Frequency

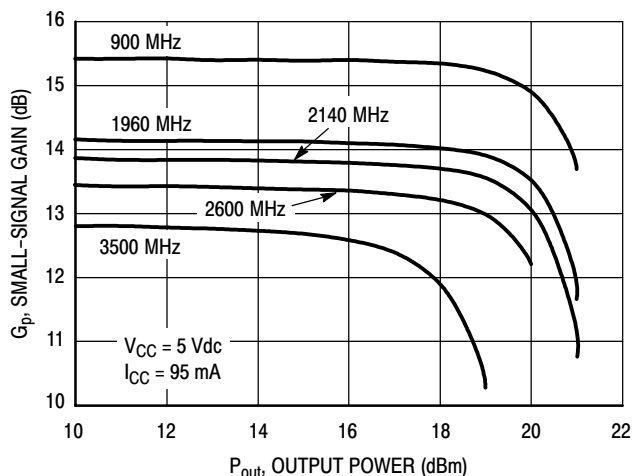

Figure 4. Small-Signal Gain versus Output Power

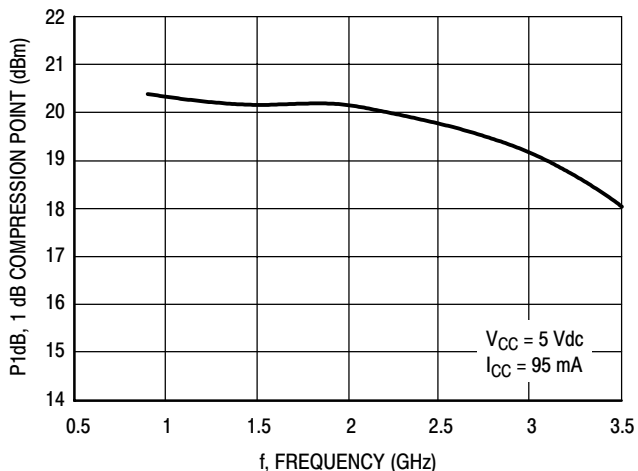

Figure 5. P1dB versus Frequency

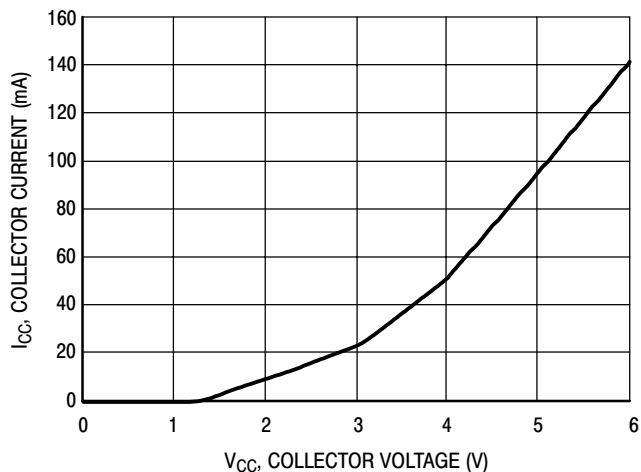

Figure 6. Collector Current versus Collector Voltage

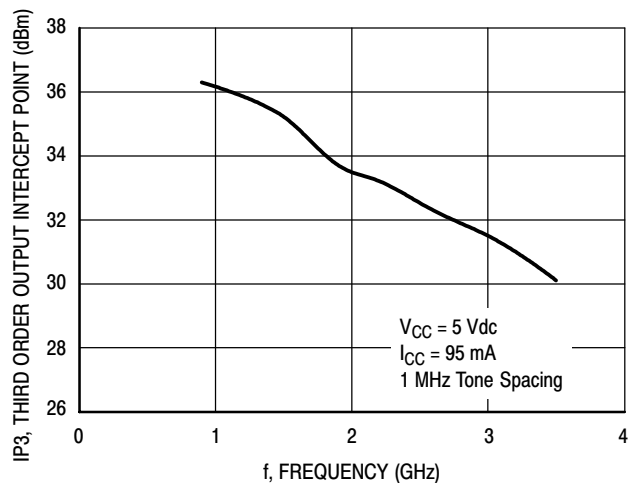

Figure 7. Third Order Output Intercept Point versus Frequency

50 OHM TYPICAL CHARACTERISTICS

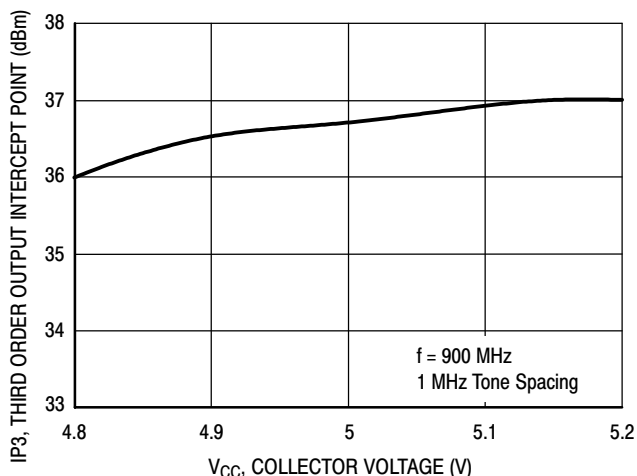

Figure 8. Third Order Output Intercept Point versus Collector Voltage

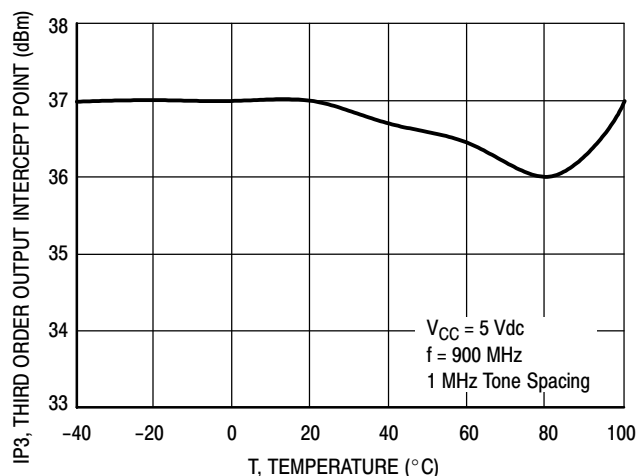

Figure 9. Third Order Output Intercept Point versus Case Temperature

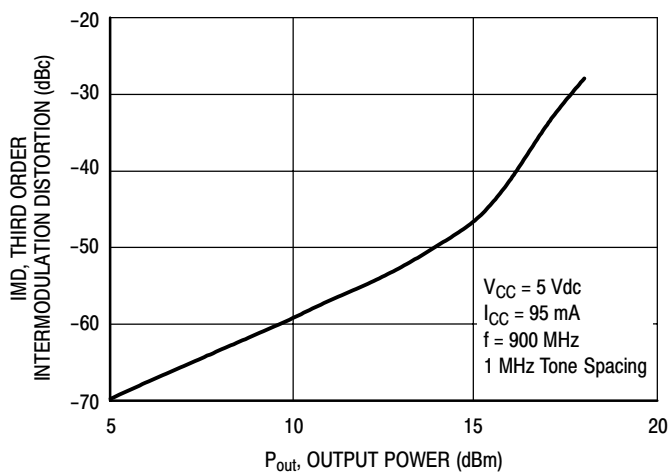
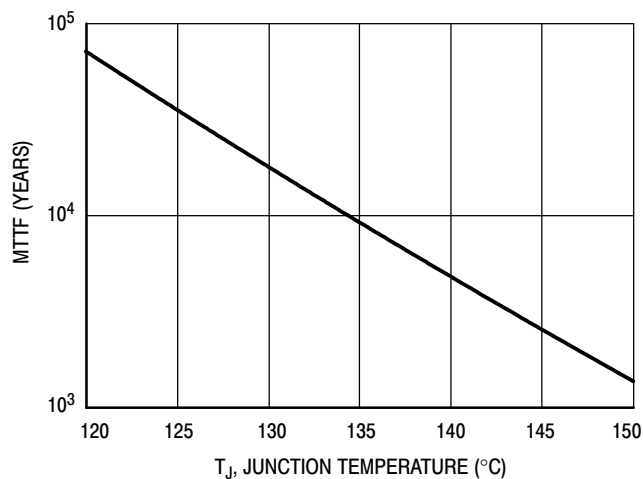

Figure 10. Third Order Intermodulation versus Output Power



NOTE: The MTTF is calculated with $V_{CC} = 5 \text{ Vdc}$, $I_{CC} = 95 \text{ mA}$

Figure 11. MTTF versus Junction Temperature

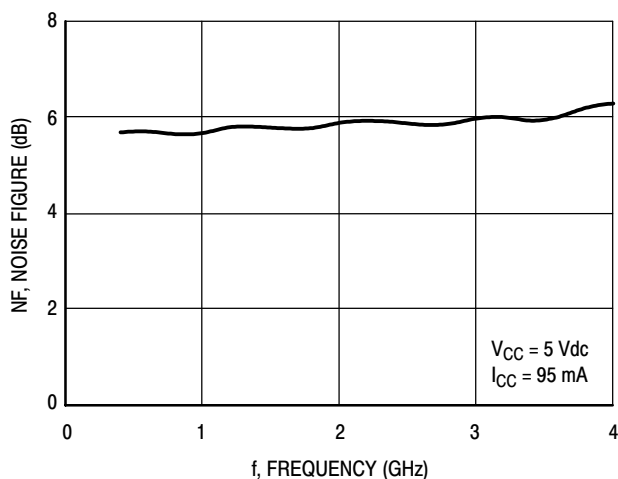

Figure 12. Noise Figure versus Frequency

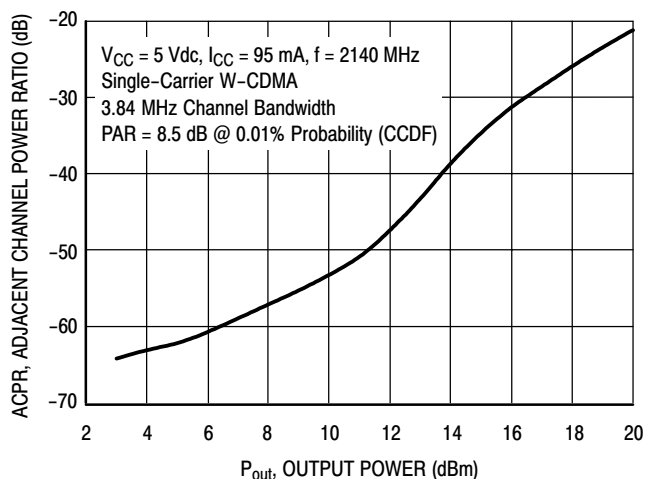

Figure 13. Single-Carrier W-CDMA Adjacent Channel Power Ratio versus Output Power

50 OHM APPLICATION CIRCUIT: 40-800 MHz

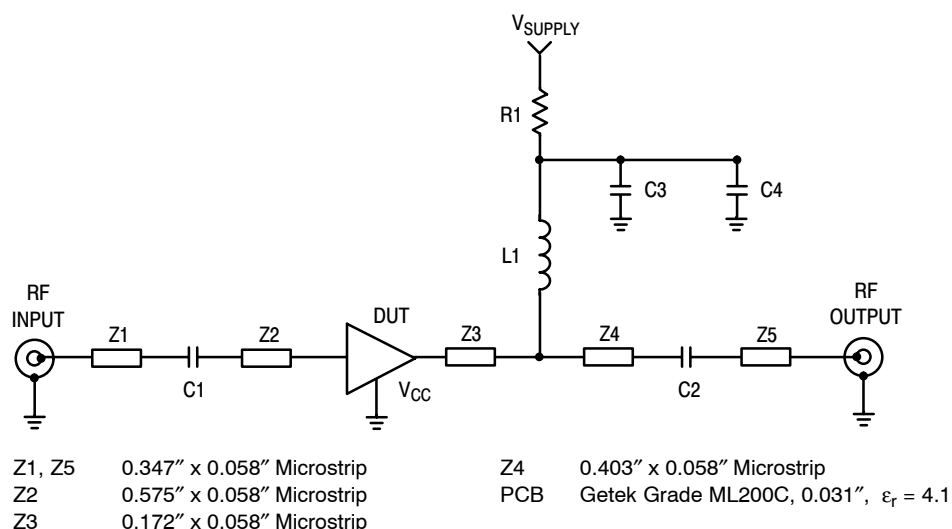

Figure 14. 50 Ohm Test Circuit Schematic

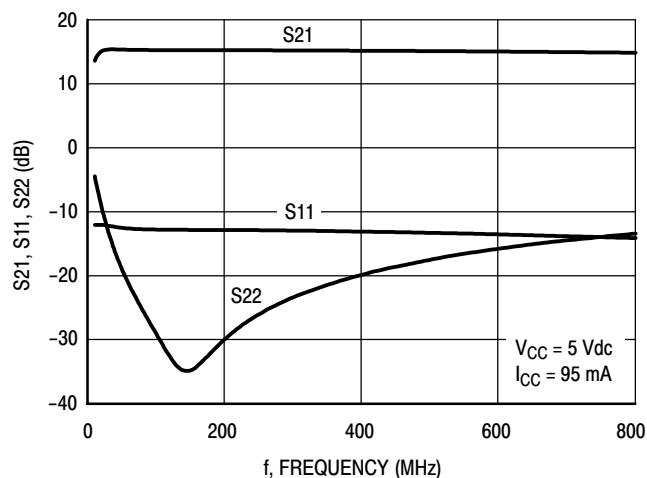

Figure 15. S21, S11 and S22 versus Frequency

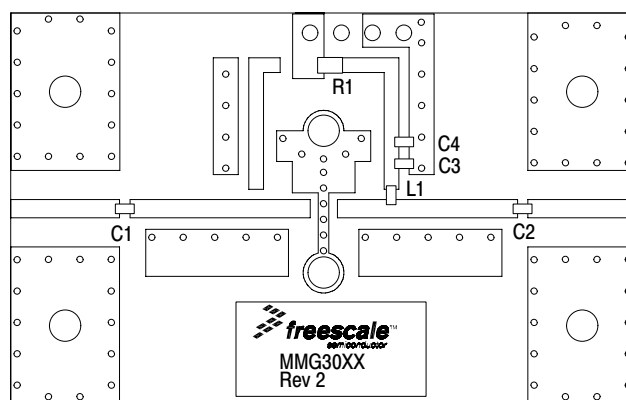

Figure 16. 50 Ohm Test Circuit Component Layout

Table 8. 50 Ohm Test Circuit Component Designations and Values

Part	Description	Part Number	Manufacturer
C1, C2	0.01 μ F Chip Capacitors	C0603C103J5RAC	Kemet
C3	0.1 μ F Chip Capacitor	C0603C104J5RAC	Kemet
C4	1 μ F Chip Capacitor	C0603C105J5RAC	Kemet
L1	470 nH Chip Inductor	BK2125HM471 - T	Taiyo Yuden
R1	0 Ω , 1/10 W Chip Resistor	CRCW06030000ZKEA	Vishay

50 OHM APPLICATION CIRCUIT: 800-3600 MHz

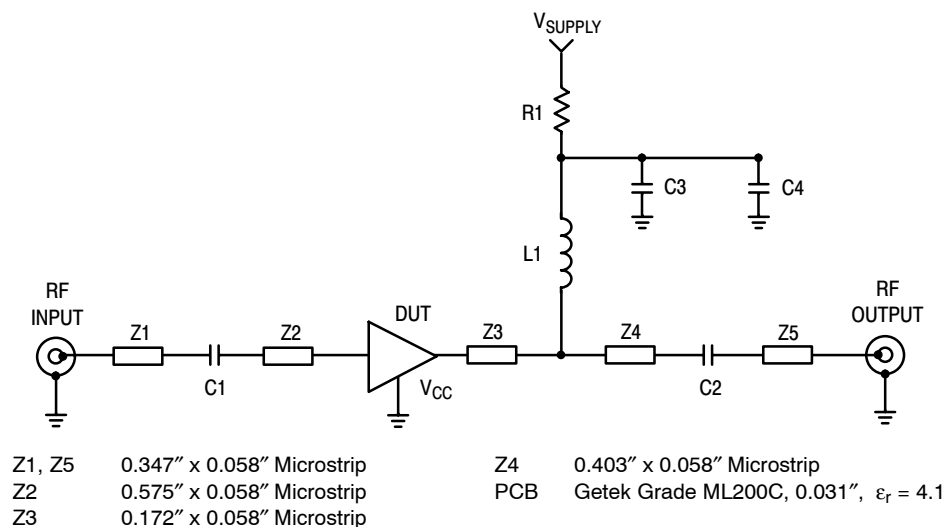

Figure 17. 50 Ohm Test Circuit Schematic

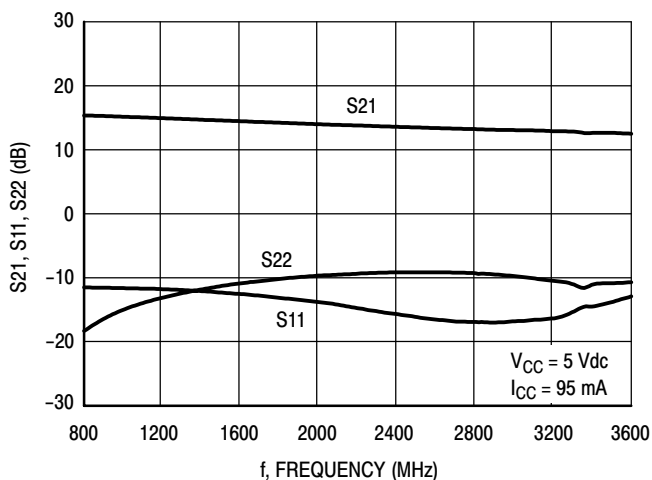

Figure 18. S21, S11 and S22 versus Frequency

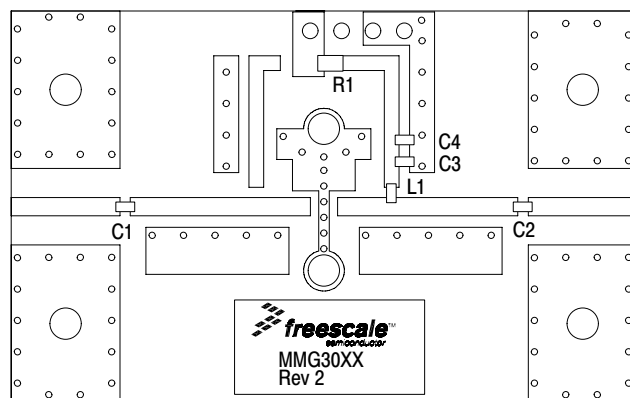

Figure 19. 50 Ohm Test Circuit Component Layout

Table 9. 50 Ohm Test Circuit Component Designations and Values

Part	Description	Part Number	Manufacturer
C1, C2	150 pF Chip Capacitors	C0603C151J5RAC	Kemet
C3	0.1 μ F Chip Capacitor	C0603C104J5RAC	Kemet
C4	1 μ F Chip Capacitor	C0603C105J5RAC	Kemet
L1	56 nH Chip Inductor	HK160856NJ-T	Taiyo Yuden
R1	0 Ω , 1/10 W Chip Resistor	CRCW06030000ZKEA	Vishay

50 OHM TYPICAL CHARACTERISTICS

Table 10. Common Emitter S-Parameters ($V_{CC} = 5 \text{ Vdc}$, $I_{CC} = 95 \text{ mA}$, $T_C = 25^\circ\text{C}$, 50 Ohm System)

f MHz	S ₁₁		S ₂₁		S ₁₂		S ₂₂	
	S ₁₁	∠ φ	S ₂₁	∠ φ	S ₁₂	∠ φ	S ₂₂	∠ φ
200	0.28	174.23	6.17	171.48	0.08	-2.66	0.06	-43.26
250	0.28	172.92	6.16	169.36	0.08	-3.32	0.07	-50.81
300	0.27	171.92	6.15	167.25	0.08	-3.93	0.08	-56.75
350	0.27	170.57	6.14	165.15	0.08	-4.60	0.09	-62.45
400	0.27	169.49	6.12	163.07	0.08	-5.22	0.09	-67.13
450	0.26	168.53	6.11	160.97	0.08	-5.85	0.10	-71.09
500	0.26	167.16	6.10	158.87	0.08	-6.50	0.11	-74.88
550	0.26	165.92	6.08	156.78	0.08	-7.14	0.12	-77.99
600	0.26	164.77	6.06	154.73	0.08	-7.76	0.13	-81.75
650	0.26	163.38	6.05	152.65	0.08	-8.41	0.14	-85.06
700	0.25	162.57	6.03	150.58	0.08	-9.03	0.14	-88.16
750	0.25	161.36	6.01	148.53	0.08	-9.64	0.15	-91.28
800	0.25	160.35	5.99	146.50	0.08	-10.26	0.16	-93.96
850	0.25	159.29	5.97	144.45	0.08	-10.88	0.17	-96.90
900	0.25	158.03	5.95	142.41	0.08	-11.52	0.18	-99.99
950	0.24	157.14	5.93	140.38	0.08	-12.14	0.18	-102.70
1000	0.24	156.02	5.91	138.38	0.08	-12.78	0.19	-105.47
1050	0.24	154.89	5.88	136.37	0.08	-13.38	0.20	-108.27
1150	0.24	153.09	5.83	132.34	0.08	-14.64	0.21	-114.23
1200	0.24	152.30	5.80	130.37	0.08	-15.28	0.22	-117.17
1250	0.24	151.41	5.77	128.39	0.08	-15.94	0.22	-120.26
1300	0.24	150.63	5.75	126.41	0.08	-16.57	0.23	-123.42
1350	0.24	150.09	5.72	124.46	0.08	-17.17	0.24	-126.34
1400	0.24	149.52	5.69	122.50	0.08	-17.81	0.24	-129.61
1450	0.24	149.15	5.67	120.54	0.08	-18.46	0.25	-132.32
1500	0.23	148.71	5.65	118.61	0.08	-19.07	0.26	-134.63
1550	0.23	147.76	5.62	116.65	0.08	-19.73	0.26	-136.77
1600	0.23	146.51	5.60	114.72	0.08	-20.39	0.27	-138.90
1650	0.23	145.11	5.57	112.79	0.08	-21.04	0.28	-141.13
1900	0.23	138.41	5.41	103.23	0.08	-24.38	0.31	-152.46
2150	0.24	132.77	5.23	93.77	0.08	-27.79	0.35	-163.83
2400	0.25	128.41	5.05	84.48	0.08	-31.33	0.38	-175.54
2650	0.26	124.16	4.87	75.21	0.08	-35.09	0.40	172.45
2900	0.28	119.27	4.69	66.04	0.08	-39.03	0.43	161.50
2950	0.28	118.39	4.65	64.24	0.08	-39.86	0.44	159.35
3000	0.28	117.49	4.62	62.43	0.09	-40.65	0.44	157.23
3050	0.28	116.75	4.59	60.59	0.09	-41.48	0.45	154.83
3100	0.29	116.03	4.55	58.77	0.09	-42.33	0.46	152.37
3150	0.29	115.21	4.52	56.97	0.09	-43.16	0.46	150.02
3200	0.29	114.41	4.48	55.15	0.09	-44.01	0.47	147.68
3250	0.29	113.69	4.44	53.36	0.09	-44.83	0.48	145.58
3300	0.29	112.97	4.41	51.59	0.09	-45.67	0.48	143.48
3350	0.29	112.24	4.37	49.84	0.09	-46.48	0.49	141.43

Table 10. Common Emitter S-Parameters ($V_{CC} = 5 \text{ Vdc}$, $I_{CC} = 90 \text{ mA}$, $T_C = 25^\circ\text{C}$, 50 Ohm System) (continued)

f MHz	S ₁₁		S ₂₁		S ₁₂		S ₂₂	
	S ₁₁	∠ φ	S ₂₁	∠ φ	S ₁₂	∠ φ	S ₂₂	∠ φ
3400	0.29	111.50	4.34	48.07	0.09	-47.31	0.49	139.46
3450	0.29	110.37	4.30	45.96	0.09	-48.32	0.50	137.08
3500	0.29	109.50	4.27	44.53	0.09	-49.01	0.50	135.57
3550	0.29	108.57	4.23	42.83	0.09	-49.82	0.51	133.81
3600	0.29	107.57	4.20	41.14	0.09	-50.64	0.52	132.08

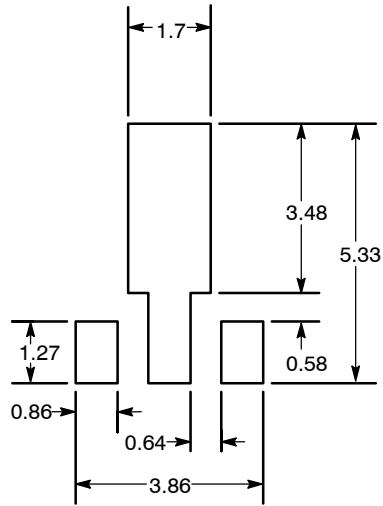

Recommended Solder Stencil

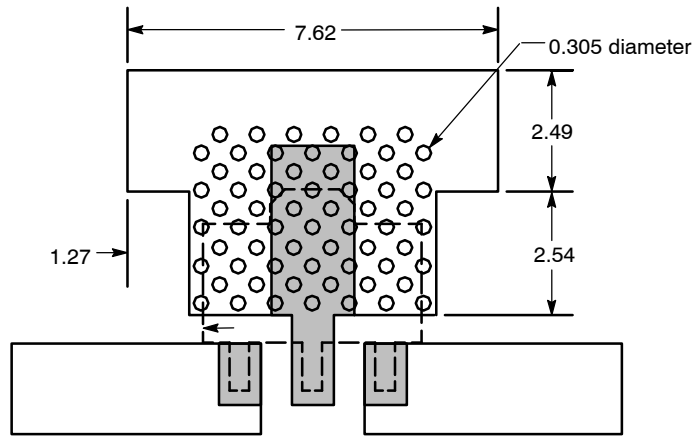

NOTES:

1. THERMAL AND RF GROUNDING CONSIDERATIONS SHOULD BE USED IN PCB LAYOUT DESIGN.
2. DEPENDING ON PCB DESIGN RULES, AS MANY VIAS AS POSSIBLE SHOULD BE PLACED ON THE LANDING PATTERN.
3. IF VIAS CANNOT BE PLACED ON THE LANDING PATTERN, THEN AS MANY VIAS AS POSSIBLE SHOULD BE PLACED AS CLOSE TO THE LANDING PATTERN AS POSSIBLE FOR OPTIMAL THERMAL AND RF PERFORMANCE.
4. RECOMMENDED VIA PATTERN SHOWN HAS 0.381 x 0.762 MM PITCH.

Figure 20. Recommended Mounting Configuration

PACKAGE DIMENSIONS

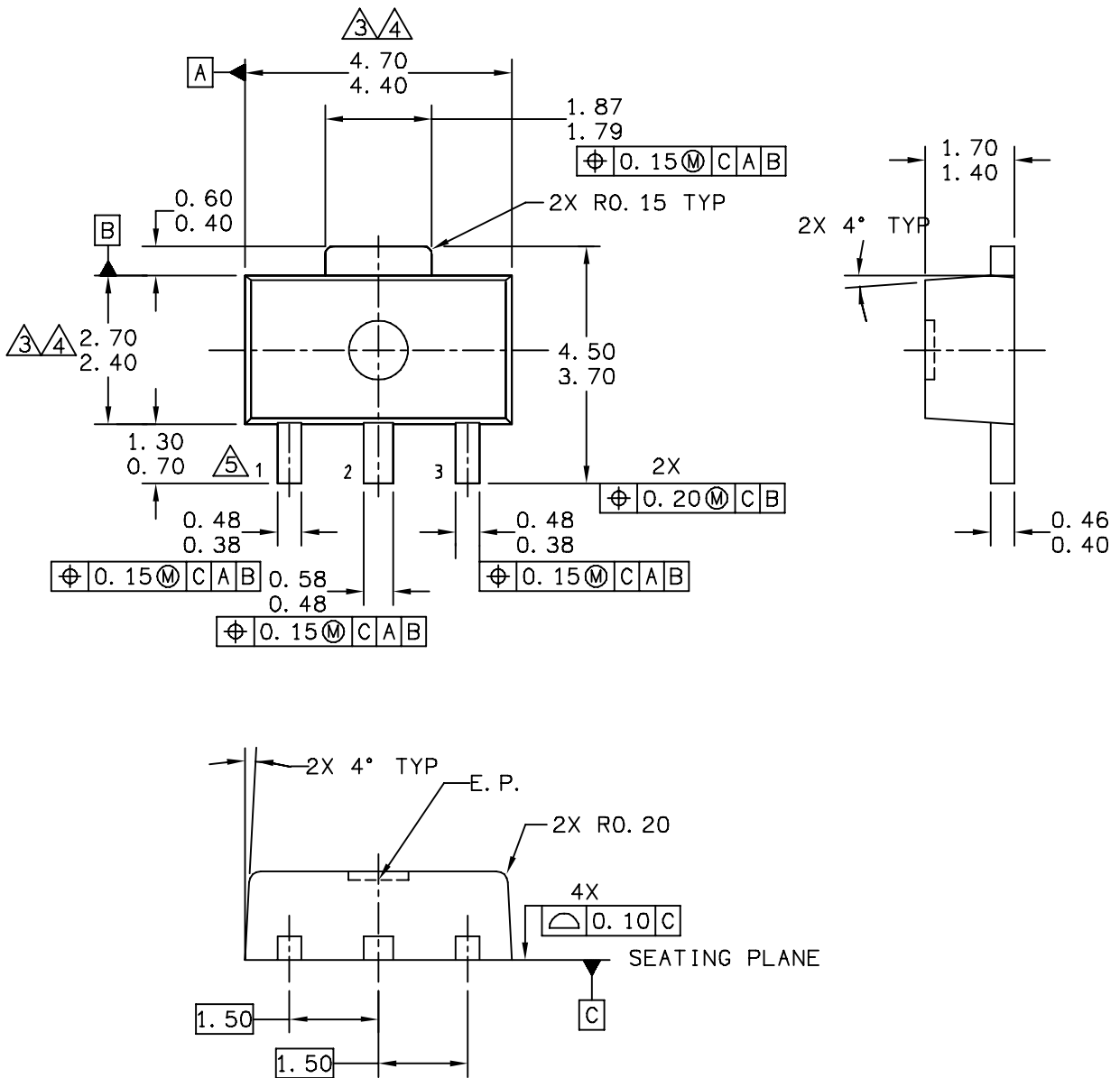

© FREESCALE SEMICONDUCTOR, INC. ALL RIGHTS RESERVED.	MECHANICAL OUTLINE	PRINT VERSION NOT TO SCALE	
TITLE: SOT-89, 4 LEAD, 4.5 X 2.5 PKG, 1.5 MM PITCH	DOCUMENT NO: 98ASA10586D		REV: D
	CASE NUMBER: 1514-02		27 JUN 2007
	STANDARD: NON-JEDEC		

MMG3015NT1

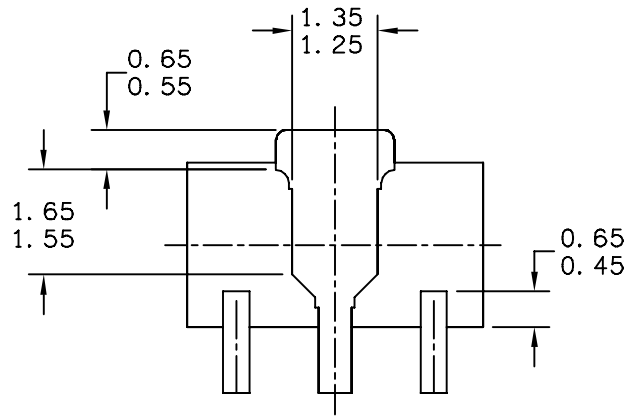

BOTTOM VIEW

CASE STYLE:

STYLE 1:

PIN 1. RF INPUT
 PIN 2. GROUND
 PIN 3. RF OUTPUT

STYLE 2:

PIN 1. GATE
 PIN 2. SOURCE
 PIN 3. DRAIN

© FREESCALE SEMICONDUCTOR, INC. ALL RIGHTS RESERVED.	MECHANICAL OUTLINE	PRINT VERSION NOT TO SCALE	
TITLE: SOT-89, 4 LEAD, 4.5 X 2.5 PKG, 1.5 MM PITCH	DOCUMENT NO: 98ASA10586D	REV: D	
	CASE NUMBER: 1514-02	27 JUN 2007	
	STANDARD: NON-JEDEC		

NOTES:

1 DIMENSIONING AND TOLERANCING PER ASME Y14.5M – 1994.

2 ALL DIMENSIONS ARE IN MILLIMETERS.

3 DIMENSIONS DOES NOT INCLUDE MOLD FLASH. PROTRUSIONS OR GATE BURRS. MOLD FLASH, PROTRUSIONS OR GATE BURRS SHALL NOT EXCEED 0.5mm PER END. DIMENSION DOES NOT INCLUDE INTERLEAD FLASH OR PROTRUSION. INTERLEAD FLASH OR PROTRUSION SHALL NOT EXCEED 0.5 mm PER SIDE.

4 DIMENSION ARE DETERMINED AT THE OUTMOST EXTREMES OF THE PLASTIC BODY EXCLUSIVE OF MOLD FLASH, TIE BAR BURRS, GATE BURRS AND INTERLEAD FLASH, BUT INCLUDING ANY MISMATCH BETWEEN THE TOP AND BOTTOM OF THE PLASTIC BODY.

5 TERMINAL NUMBERS ARE SHOWN FOR REFERENCE ONLY.

© FREESCALE SEMICONDUCTOR, INC. ALL RIGHTS RESERVED.	MECHANICAL OUTLINE	PRINT VERSION NOT TO SCALE	
TITLE: SOT-89, 4 LEAD, 4.5 X 2.5 PKG, 1.5 MM PITCH	DOCUMENT NO: 98ASA10586D	REV: D	
	CASE NUMBER: 1514-02	27 JUN 2007	
	STANDARD: NON-JEDEC		

PRODUCT DOCUMENTATION

Refer to the following documents to aid your design process.

Application Notes

- AN1955: Thermal Measurement Methodology of RF Power Amplifiers
- AN3100: General Purpose Amplifier Biasing

REVISION HISTORY

The following table summarizes revisions to this document.

Revision	Date	Description
0	Aug. 2007	<ul style="list-style-type: none">• Initial Release of Data Sheet

How to Reach Us:

Home Page:

www.freescale.com

Web Support:

<http://www.freescale.com/support>

USA/Europe or Locations Not Listed:

Freescale Semiconductor, Inc.
Technical Information Center, EL516
2100 East Elliot Road
Tempe, Arizona 85284
+1-800-521-6274 or +1-480-768-2130
www.freescale.com/support

Europe, Middle East, and Africa:

Freescale Halbleiter Deutschland GmbH
Technical Information Center
Schatzbogen 7
81829 Muenchen, Germany
+44 1296 380 456 (English)
+46 8 52200080 (English)
+49 89 92103 559 (German)
+33 1 69 35 48 48 (French)
www.freescale.com/support

Japan:

Freescale Semiconductor Japan Ltd.
Headquarters
ARCO Tower 15F
1-8-1, Shimo-Meguro, Meguro-ku,
Tokyo 153-0064
Japan
0120 191014 or +81 3 5437 9125
support.japan@freescale.com

Asia/Pacific:

Freescale Semiconductor Hong Kong Ltd.
Technical Information Center
2 Dai King Street
Tai Po Industrial Estate
Tai Po, N.T., Hong Kong
+800 2666 8080
support.asia@freescale.com

For Literature Requests Only:

Freescale Semiconductor Literature Distribution Center
P.O. Box 5405
Denver, Colorado 80217
1-800-441-2447 or 303-675-2140
Fax: 303-675-2150
LDCForFreescaleSemiconductor@hibbertgroup.com

Information in this document is provided solely to enable system and software implementers to use Freescale Semiconductor products. There are no express or implied copyright licenses granted hereunder to design or fabricate any integrated circuits or integrated circuits based on the information in this document.

Freescale Semiconductor reserves the right to make changes without further notice to any products herein. Freescale Semiconductor makes no warranty, representation or guarantee regarding the suitability of its products for any particular purpose, nor does Freescale Semiconductor assume any liability arising out of the application or use of any product or circuit, and specifically disclaims any and all liability, including without limitation consequential or incidental damages. "Typical" parameters that may be provided in Freescale Semiconductor data sheets and/or specifications can and do vary in different applications and actual performance may vary over time. All operating parameters, including "Typicals", must be validated for each customer application by customer's technical experts. Freescale Semiconductor does not convey any license under its patent rights nor the rights of others. Freescale Semiconductor products are not designed, intended, or authorized for use as components in systems intended for surgical implant into the body, or other applications intended to support or sustain life, or for any other application in which the failure of the Freescale Semiconductor product could create a situation where personal injury or death may occur. Should Buyer purchase or use Freescale Semiconductor products for any such unintended or unauthorized application, Buyer shall indemnify and hold Freescale Semiconductor and its officers, employees, subsidiaries, affiliates, and distributors harmless against all claims, costs, damages, and expenses, and reasonable attorney fees arising out of, directly or indirectly, any claim of personal injury or death associated with such unintended or unauthorized use, even if such claim alleges that Freescale Semiconductor was negligent regarding the design or manufacture of the part.

Freescale™ and the Freescale logo are trademarks of Freescale Semiconductor, Inc. All other product or service names are the property of their respective owners.

© Freescale Semiconductor, Inc. 2007. All rights reserved.

